

SUMIDIA Chipbreaker „Break Master“ Type

# NLD / NGD

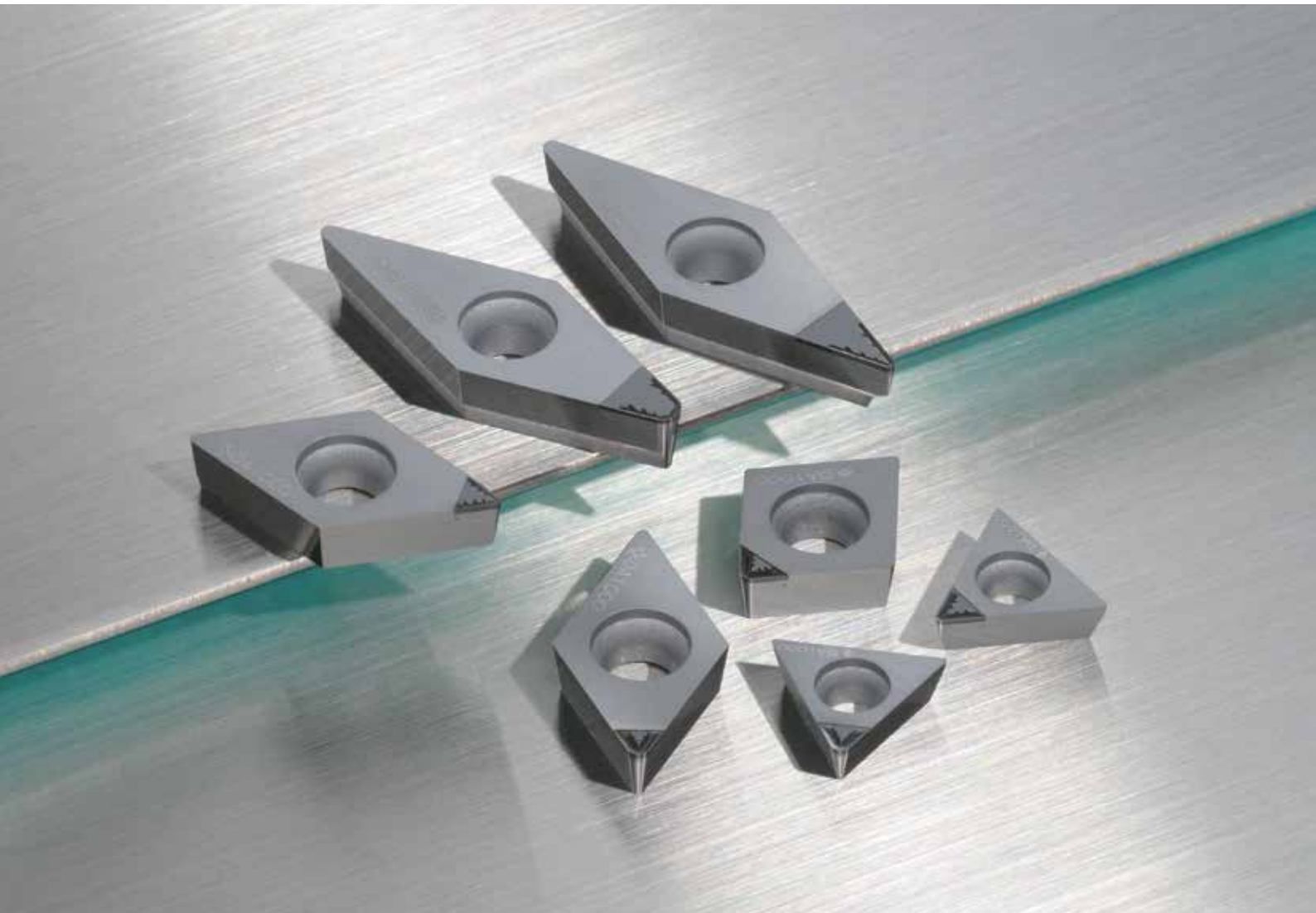

- PCD insert with chip breaker for aluminium alloys
- Excellent chip control in finishing applications
- Improved work efficiency by solving chip control problems
- Stable long tool life by employing high-toughness grade DA1000



**SUMITOMO**

CARBIDE - CBN - DIAMOND

# SUMIDIA Break Master NLD Type / NGD Type

## Line Up of Breakers

### ● NLD Type Chip Breaker

Achieves excellent chip control for finishing.

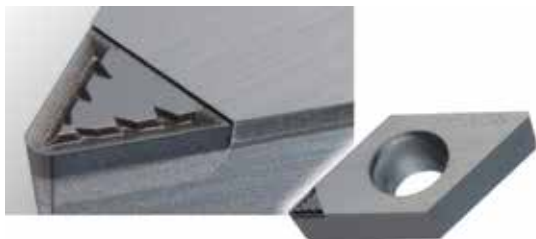

### ● NGD Type Chip Breaker

Achieves excellent chip control for semi finishing.



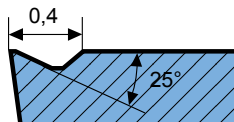
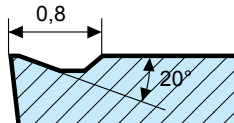

Breaker	Grades	Chip Breaker Cross-Section Shape	Features
NLD Type	DA1000		Achieves excellent surface quality and outstanding chip control thanks to its 3-D finishing chip breaker design in combination with the sharp cutting edge.
NGD Type			Achieves stable chip control in a wide application range from semi finishing to general cutting thanks to its adjusted 3-D chip breaker design.

## Application Range

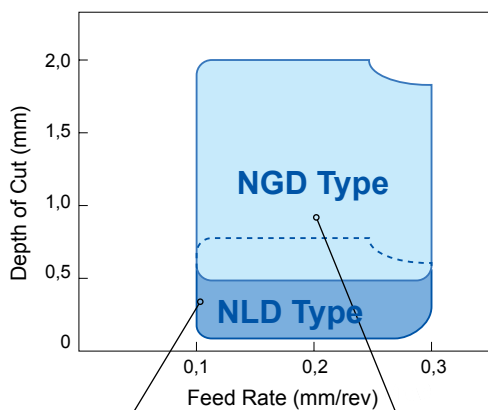

### ● Wrought Aluminium Alloy (A6061)

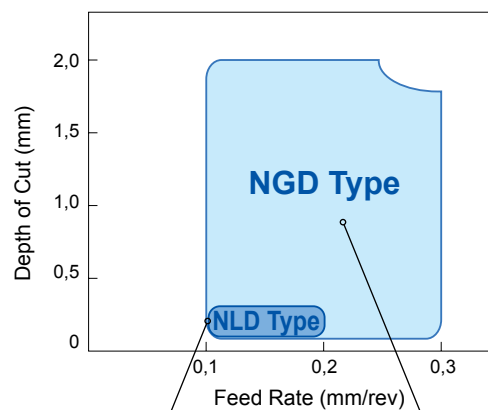

Work Material: A6061	Work Material: A6061
Insert: DCMT11T304 <b>NLD</b> NF	Insert: DCMT11T304 <b>NGD</b> NF
Cutting Conditions: $v_c=400\text{m/min}$ $f=0,1\text{mm/rev}$ $a_p=0,2\text{mm}$	Cutting Conditions: $v_c=400\text{m/min}$ $f=0,2\text{mm/rev}$ $a_p=1,0\text{mm}$
	

### ● Casted Aluminium Alloy (ADC12)



Work Material: ADC12	Work Material: ADC12
Insert: DCMT11T304 <b>NLD</b> NF	Insert: DCMT11T304 <b>NGD</b> NF
Cutting Conditions: $v_c=400\text{m/min}$ $f=0,1\text{mm/rev}$ $a_p=0,2\text{mm}$	Cutting Conditions: $v_c=400\text{m/min}$ $f=0,2\text{mm/rev}$ $a_p=1,0\text{mm}$
	

Covers a wide application range with 2 types of chip breakers.

# SUMIDIA Break Master

## NLD Type / NGD Type

### Recommended Cutting Conditions

Work Material	Chip Breaker	Grade	Cutting Conditions		
			Cutting Speed (m/min)	Feed Rate (mm/rev)	Depth of Cut (mm)
Wrought Aluminium Alloy (Si content: < 12,6%)	NLD	DA1000	100 - <b>1000</b> - 3000	0,1 - <b>0,15</b> - 0,3	0,1 - <b>0,3</b> - 0,8
	NGD	DA1000	100 - <b>1000</b> - 3000	0,1 - <b>0,15</b> - 0,3	0,5 - <b>1,0</b> - 2,0
Casting Aluminium Alloy (Si content: ≥ 12,6%)	NLD	DA1000	100 - <b>1000</b> - 3000	0,1 - <b>0,15</b> - 0,2	0,1 - <b>0,2</b> - 0,3
	NGD	DA1000	100 - <b>1000</b> - 3000	0,1 - <b>0,15</b> - 0,3	0,1 - <b>1,0</b> - 2,0

Min. - Optimum - Max.



### Inserts

#### NLD Type

Shape	Relief Angle	Cat. No.	Stock		Dimensions (mm)			
			DA 1000	Cutting Edge Length	Inscribed Circle	Thick-ness	Screw Hole Ø	Nose Radi- us
	7°	CCMT 060202NLDNF	○	2,9	6,35	2,38	2,8	0,2
		060204NLDNF	○	2,9				0,4
		CCMT 09T302NLDNF	○	2,9	9,525	3,97	4,4	0,2
		09T304NLDNF	○	2,9				0,4
		09T308NLDNF	○	2,8				0,8
	7°	DCMT 070202NLDNF	○	3,1	6,35	2,38	2,8	0,2
		070204NLDNF	○	2,9				0,4
		DCMT 11T302NLDNF	○	3,1	9,525	3,97	4,4	0,2
		11T304NLDNF	○	2,9				0,4
		11T308NLDNF	○	2,5				0,8
	11°	TPMT 080202NLDNF	○	2,9	4,76	2,38	2,4	0,2
		080204NLDNF	○	2,8				0,4
		TPMT 090202NLDNF	○	3,1	5,56	2,38	2,8	0,2
		090204NLDNF	○	2,9				0,4
		TPMT 110202NLDNF	○	3,1				6,35
		110204NLDNF	○	2,9	0,4			
		TPMT 110302NLDNF	○	3,1	6,35	3,18	3,4	0,2
		110304NLDNF	○	2,9				0,4
		110308NLDNF	○	2,7				0,8
		TPMT 160402NLDNF	○	3,1	9,525	4,76	4,4	0,2
160404NLDNF	○	2,9	0,4					
160408NLDNF	○	2,7	0,8					
	7°	VCMT 110302NLDNF	○	3,8	6,35	3,18	2,8	0,2
		110304NLDNF	○	3,4				0,4
		VCMT 160404NLDNF	○	6,5	9,525	4,76	4,4	0,4
		160408NLDNF	○	5,6				0,8
		160412NLDNF	○	4,8				1,2

#### NGD Type

Shape	Relief Angle	Cat. No.	Stock		Dimensions (mm)			
			DA 1000	Cutting Edge Length	Inscribed Circle	Thick-ness	Screw Hole Ø	Nose Radi- us
	7°	CCMT 060202NGDNF	○	2,9	6,35	2,38	2,8	0,2
		060204NGDNF	○	2,9				0,4
		CCMT 09T302NGDNF	○	2,9	9,525	3,97	4,4	0,2
		09T304NGDNF	○	2,9				0,4
		09T308NGDNF	○	2,8				0,8
	7°	DCMT 070202NGDNF	○	3,1	6,35	2,38	2,8	0,2
		070204NGDNF	○	2,9				0,4
		DCMT 11T302NGDNF	○	3,1	9,525	3,97	4,4	0,2
		11T304NGDNF	○	2,9				0,4
		11T308NGDNF	○	2,5				0,8
	11°	TPMT 080202NGDNF	○	2,9	4,76	2,38	2,4	0,2
		080204NGDNF	○	2,8				0,4
		TPMT 090202NGDNF	○	3,1	5,56	2,38	2,8	0,2
		090204NGDNF	○	2,9				0,4
		TPMT 110202NGDNF	○	3,1				6,35
		110204NGDNF	○	2,9	0,4			
		TPMT 110302NGDNF	○	3,1	6,35	3,18	3,4	0,2
		110304NGDNF	○	2,9				0,4
		110308NGDNF	○	2,7				0,8
		TPMT 160402NGDNF	○	3,1	9,525	4,76	4,4	0,2
160404NGDNF	○	2,9	0,4					
160408NGDNF	○	2,7	0,8					
	7°	VCMT 110302NGDNF	○	3,8	6,35	3,18	2,8	0,2
		110304NGDNF	○	3,4				0,4
		VCMT 160404NGDNF	○	6,5	9,525	4,76	4,4	0,4
		160408NGDNF	○	5,6				0,8
		160412NGDNF	○	4,8				1,2

○ Japan stock



# SUMIDIA Break Master NLD Type / NGD Type

## Application Examples

### Breakmaster NLD Type

**Internal Turning of Machine Component**

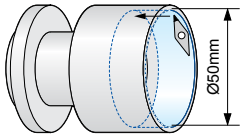
Provides good chip control in small-depth cutting of wrought Al alloy.



Breakmaster **NLD** type      Without chip breaker

Work Material: A6061  
 Insert: VCMT110302 **NLD** NF (DA1000)  
 Cutting Conditions:  $v_c=200\text{m/min}$ ,  $f=0,20\text{mm/rev}$ ,  $a_p=0,10\text{mm}$ , wet

### Breakmaster NGD Type

**Internal Turning of Transmission Component**

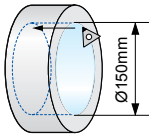
Offers good chip control in casted material. Small chips - easy to remove.







Breakmaster **NGD** type      Without chip breaker

Work Material: ADC12  
 Insert: TPMT110304 **NGD** NF (DA1000)  
 Cutting Conditions:  $v_c=400\text{m/min}$ ,  $f=0,23\text{mm/rev}$ ,  $a_p=1,20\text{mm}$ , wet

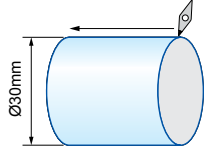
### External Turning of Piston

Provides good chip control in external turning of wrought material.







Breakmaster **NLD** type      Without chip breaker

Work Material: A6061  
 Insert: VCMT160412 **NLD** NF (DA1000)  
 Cutting Conditions:  $v_c=300\text{m/min}$ ,  $f=0,10\text{mm/rev}$ ,  $a_p=0,20\text{mm}$ , wet

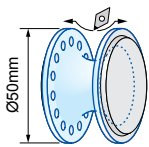
### External Turning of Automotive Component

Offers good chip control in external turning of casted material.

Breakmaster **NGD** type      Without chip breaker

Work Material: AISi7Mg0,3  
 Insert: DCMT110308 **NGD** NF (DA1000)  
 Cutting Conditions:  $v_c=345\text{m/min}$ ,  $f=0,15\text{mm/rev}$ ,  $a_p=0,25\text{mm}$ , wet



CARBIDE - CBN - DIAMOND

(Germany)

SUMITOMO ELECTRIC Hartmetall GmbH  
 Siemensring 84, D - 47877 Willich

Tel. +49(0)2154 4992-0, Fax +49(0)2154 41072  
 e-Mail: [Info@SumitomoTool.com](mailto:Info@SumitomoTool.com)  
 Internet: [www.sumitomoTool.com](http://www.sumitomoTool.com)



(UK and Ireland)

SUMITOMO ELECTRIC Hardmetal Ltd.  
 Summerleys Road, Princes Risborough  
 Buckinghamshire HP27 9PW, UK

Tel. +44(0)1844 342081, Fax: +44(0)1844 342415  
 e-Mail: [enquiries@sumitomo-hardmetal.co.uk](mailto:enquiries@sumitomo-hardmetal.co.uk)  
 Internet: [www.sumitomo-hardmetal.co.uk](http://www.sumitomo-hardmetal.co.uk)



Distributed by: